

5600SE Simplex Series

Installation Operation Maintenance Manual

Simplex Softener With 5600SE Series Downflow Brining Valve

Models

10 lit

14 lit

20 lit

25 lit

30 lit

40 lit

50 lit

60 lit

75 lit

5600SE Simplex Series Watersoftener

Installation Operation Maintenance Manual

CONTENTS

NOS.		PAGE
1.0	GENERAL NOTES	5
2.0	THE SOFTENING PROCESS	6
2.1	In Service	6
2.2	Regeneration	6
2.3	The Regeneration Process	7
2.4	Meter Control of Regeneration Initiation	7
2.5	Time Clock Control of Regeneration Initiation	8
3.0	UNPACKING AND PARTS IDENTIFICATION	9
3.1	Basic Packages	9
3.2	Unpacking Notes	9
3.3	Missing or Damaged Goods	9
4.0	TEMPORARY STORAGE	9
5.0	DESCRIPTION OF PLANT COMPONENTS	10
5.1	Softener Vessel and Internals	10
5.2	Control Valve	10
5.3	Regeneration Controller and Transformer	10
5.4	Brine System	11
5.5	Blending System	11
6.0	PRE-INSTALLATION CHECKS	12
6.1	Mechanical	12
6.1.1	Foundations/Drainage	12
6.1.2	Operating Space	12
6.1.3	Incoming Water	12
6.1.4	Pipework	13
6.1.5	Water Supply Company Requirements	13
6.2	Electrical	13

5600SE Simplex Series Watersoftener

Installation Operation Maintenance Manual

NOS.		PAGE
7.0	ASSEMBLY/INSTALLATION	14
7.1	Mechanical	14
7.1.1	Simplex Models	14
7.1.2	Charging the Resin	14
7.1.4	Assembling the Control Valve	15
7.1.5	Attaching the Control Valve	15
7.1.6	Brine System	15
7.1.7	Pipework	15
7.1.8	Storage tank ball valve	15
7.1.9	Drains and Overflow Connections	16
7.1.10	Blending System	16
7.2	Electrical	17
7.2.1	Mains Supply	17
7.2.2	Transformer	17
8.0	COMMISSIONING	18
8.1	Introduction	18
8.2	Controller Setting	18
8.2.1	Setting the Time of Day	18
8.2.2	Setting the Site Program	19
8.3	Brine System	20
8.3.1	Salt Tank Filling	20
8.4	Pre Service Flush and Regeneration	21
8.5	Blending System	21
9.5	Temporary Shut-down	24
9.6	Changes in Incoming Water	24
9.7	Routine Monitoring	25

5600SE Simplex Series Watersoftener

Installation Operation Maintenance Manual

NOS.		PAGE
9.0	OPERATION	22
9.1	Normal Operation	23
9.2	Refilling with Salt	23
9.3	Manual Regeneration	23
9.4	By-passing the Softener	23
9.5	Temporary Shut-down	24
9.6	Changes in Incoming Water	24
9.7	Routine Monitoring	25
10.0	FAULT FINDING AND RECTIFICATION	26
10.1	No Flow to Service	26
10.2	Poor Treated Water Quality	26
10.3	No Regeneration	27
10.4	Unsatisfactory Capacity between Regeneration's	27
11.0	WARRANTY AND SERVICE	28
11.1	After Sale Warranty	28
12.0	TECHNICAL DATA	29
12.1	Process and Operating	29
12.2	Engineering Data	31
13.0	FACTORY PROGRAMMING	
13.1	Master Programming Setup Summary	33
13.2	Master Programming	35
13.3	Softener Outputs	37
13.4	Custom programming	38
13.4.1	Using Blender	38
13.4.2	Immediate Regeneration	38
14.0	DRAWINGS	
13.1	General Installation	39
15.0	CE CERTIFICATE	40
APPENDIX I		
Valve manufacturer's manual including parts lists and exploded diagrams		

5600SE Simplex Series Watersoftener

Installation Operation Maintenance Manual

1.0 GENERAL NOTES

These instructions cover the 5600SE/5700 Range of Simplex Water Softeners, which includes models ranging in size from 10-75 litres resin volume.

It is recommended that these instructions are read throughout before commencing any work on the unit, particularly if you have no previous experience of installing and using a water softener.

The installation of a softener is very straightforward, and the only adjustments to be made to the controller program are setting the time of day and water hardness as detailed in Section 8.2.2. However we have tried to make these instructions as comprehensive as possible to answer any queries you may have about the functioning of your softener.

This softener will require salt for regeneration. We recommend the use of proprietary 'pellet' or 'tablet' salt.

Drinking softened water has not been shown to be harmful to normal healthy children and adults, but softened water contains a higher level of Sodium than a hard town mains supply. This is of concern to individuals on low Sodium diets or for babies fed with powder formula milk that already contains Sodium. It is therefore recommended that a separate un-softened drinking water supply is left in place or installed on a drinking water faucet. If a cartridge type water filter is installed on the drinking water line, this must be fed with un-softened water.

In the appendix to this manual is the original valve manufacturer's handbook. This is written for American customers and has a number of small differences in the setting up instructions from those used in Europe. In the event of confusion, refer to the data in this manual rather than in the valve manufacturer's handbook!

5600SE Simplex Series Watersoftener

Installation Operation Maintenance Manual

2.0 THE SOFTENING PROCESS

Hardness in water is caused by the presence of dissolved salts of Calcium and Magnesium. In order to overcome the problems associated with the use of hard water, these salts must be removed. This process is called 'Softening'. One means of removing the salts is to exchange them for soluble Sodium salts. This technique is known as 'Ion Exchange Softening'.

2.1 IN SERVICE

In order to soften the water, it is passed through a bed of Ion Exchange resin beads which are contained inside a vertical cylindrical vessel. these beads are made of a synthetic material, and are usually amber or dark brown in colour and between 0.5 and 1.0 mm in diameter.

As the water flows down through the resin, the Calcium and Magnesium in the hard water are progressively exchanged for Sodium, with the result that the water which flows out of the unit contains only Sodium salts, which are not scale-forming. The Calcium and Magnesium remain, attached to the resin.

The Ion Exchange resin does not have an unlimited capacity for exchanging Calcium and Magnesium, so to keep the exit water soft it is necessary to periodically 'Regenerate' the resin to restore its capacity to soften the water.

2.2 REGENERATION

The softening process can be reversed if a strong solution of Sodium Chloride (i.e. Common salt dissolved in water -'brine') is passed through the resin.

The high concentration of Sodium allows it to exchange for the Calcium and Magnesium held on the resin, and these are then carried away to drain. The resin is left full of Sodium to enable it to soften water again.

5600SE Simplex Series Watersoftener

Installation Operation Maintenance Manual

2.3 THE REGENERATION PROCESS

The regeneration process consists of four stages:-

Backwash - Water flows upwards through the resin bed, and out to a drain. As it does so, it loosens the ion exchange beads, removes any resin 'fines' (i.e. small pieces of broken beads etc.) and cleans off any particles of dirt or pipework corrosion products which may have accumulated during the service cycle.

Brine injection/Displacement Rinse - During the first part of this stage, the concentrated salt -solution is drawn from the salt storage tank, blended with water to reduce the concentration to the correct level, and passed up through the resin. When the required quantity of brine has been drawn in, the water flows alone to push the remaining brine through the resin at the correct rate, and ensure that all the resin sees the right amount of regenerant.

Fast Rinse - This follows the brine draw/displacement rinse, and entails rinsing away the residual brine and Calcium and Magnesium salts from the resin and re-packing the resin bed down. This is done down with water flowing through the resin in the direction of service.

Salt Tank Refill - Following the fast rinse, a quantity of water sufficient to dissolve the correct amount of salt for the next regeneration is returned to the salt tank. When this has finished, the unit automatically returns to service.

2.4 METER CONTROL OF REGENERATION INITIATION

A water meter is installed in the outlet from the softener, to measure the volume of water which passes to service. This meter drives a turbine, the movement of which is measured by a magnetic sensor which sends signals to the regeneration controller. The controller microprocessor uses this information to calculate when the unit should be regenerated. Every night, at 2 am (for example), the volume of water used in the preceding days is compared to the capacity of the softener. The computer then assesses if the resin has enough capacity left to supply the next day's use, and if not, starts the regeneration.

5600SE Simplex Series Watersoftener

Installation Operation Maintenance Manual

2.5 TIME CLOCK CONTROL OF REGENERATION INITIATION

Time clock configuration valves initiate regeneration at a pre-set time after a pre-set number of days. Both the time of day for regeneration and the frequency of regeneration are adjustable.

5600SE Simplex Series Watersoftener

Installation Operation Maintenance Manual

3.0 UNPACKING AND PARTS IDENTIFICATION

3.1 BASIC PACKAGES

The softener will be delivered in a number of packages which include a glassfibre reinforced pressure vessel, a control valve, a brine tanks, one or more 25 litre bags of resin with one additional part bag, and a funnel to fill the vessel

3.2 UNPACKING NOTES

The unpacking of the softener is quite straightforward, and there are no 'hidden' items. It is advisable to keep the packages sealed until such time as they are used, to prevent dust or water entry.

Care should be taken in lifting the softener or its parts out of their cartons. It is advisable to lay large cartons on their side and slide out the softener or parts prior to standing them up.

3.3 MISSING OR DAMAGED GOODS

Immediately on receipt of the goods, it is advisable to check that all items ordered have been received. If you have any doubt that goods have been supplied as requested, please contact your supplier immediately. If any items are missing or damaged, the carrier and your supplier must be notified in writing within 3 days of receipt if a claim is to be made.

4.0 TEMPORARY STORAGE

If installation is not to start immediately after delivery, the equipment should be stored in a clean dry area, where it will not be damaged, or be subjected to temperatures below freezing.

5600SE Simplex Series Watersoftener

Installation Operation Maintenance Manual

5.0 DESCRIPTION OF PLANT COMPONENTS

5.1 SOFTENER VESSEL AND INTERNALS

The pressure vessel which contains the ion exchange resin is made from a fibreglass/epoxy resin outer layer surrounding an inner, seamless shell made from Polyethylene. The vessel has a threaded hole at the top, of 2.5 inch nominal diameter, into which the control valve fits.

All vessels are equipped with a single filter distribution system. This is attached to a central riser tube, which is connected to the control valve, and passes water into and out of the resin bed.

5.2 CONTROL VALVE

The control valve is mounted on top of the vessel, and directs the water flow in and out of the resin bed during the service and regeneration cycles. The body of the control valve is made from glass reinforced Noryl.

The valve carries out its various functions by rotating a cam that drives a piston through a series of seals and ports. Depending on the position of the piston in the seal stack, the different functions of the valve will take place

5.3 REGENERATION CONTROLLER AND TRANSFORMER

The regeneration controller is attached to the valve, and is contained in a plastic housing.

The controller is powered by 24v AC electricity, and a separate, wall mounted transformer is connected to the valve to reduce normal mains voltage down from 240v so that all the electrical supply in and around the control valve runs at a safe 24v.

5600SE Simplex Series Watersoftener

Installation Operation Maintenance Manual

5.4 BRINE SYSTEM

The brine system consists of a moulded polyethylene tank into which the brine well and brine pick up are assembled. The tank forms the salt storage container.

The brine pick-up tube is connected to the pipe from the control valve which sucks the brine from the tank. At the bottom of the brine pick-up tube is an air check valve. This serves to prevent air entering the valve when all the brine has been drawn in. Air in the system could cause spurting and 'hammering' at the taps or outlets.

5.5 BLENDING SYSTEM

In some applications, it is beneficial to retain a small proportion of the hardness, for instance, to increase the effectiveness of chemical treatments. Under these circumstances, a blending facility is provided in the valve, which allows a set proportion (depending on the raw water hardness) of the feed water to bypass the softening resin, before being blended with the softened water prior to the water meter.

5600SE Simplex Series Watersoftener

Installation Operation Maintenance Manual

6.0 PRE-INSTALLATION

6.1 MECHANICAL

6.1.1 Foundation/Drainage

The softener will not require any special foundations, provided that a firm, level area which is capable of supporting the working weight is available. (See Engineering Data, Section 12.2)

Unwanted water from the regeneration process must flow to drain, and so an open drain or gully, capable of passing the necessary flow is required (see Process and Operating Data, 12.1, for relevant flows). The total flow of water to drain depends on site conditions, but will be approximately 6 times the resin volume. The drain may be at a level no higher than 500mm above the softener valve.

A second drain is required for the brine tank overflow. This is a safety drain which will only discharge water if there is a malfunction in the control valve. Where possible this should be installed through an outside wall like a cistern overflow, where it will give a visual indication of any failure.

6.1.2 Operating Space

The space occupied by the softener can be found in the Engineering Data (Section 12.2).,

Access will be required to refill the brine tank, and to carry out adjustments or maintenance on the equipment. It is therefore recommended that a minimum of 500mm clearance be allowed in front of the unit for this purpose.

6.1.3 Incoming Water

The raw water to be fed to the softener must comply with the following:-

1. Available at all times at a flow equal to the required service flow or greater, and
2. At a pressure between 1.7 and 5.5 bar
3. Temperature between 0 and 50°C
4. Suspended solids less than 1 ppm
5. Iron less than 0.2 ppm, Manganese less than 0.1 ppm, Free Chlorine less than 1 ppm if temperature is less than 15°C, less than 0.3 ppm if temperature higher (up to 30°C)

5600SE Simplex Series Watersoftener

Installation Operation Maintenance Manual

6.1.4 Pipework

Pipework to be connected to the softener should not have an excessive amount of hardness scale deposit. Piping that is heavily built up with scale (or Iron deposits) should be replaced.

Make sure that the pipework can be connected to the softener in such a way as to impose no stresses on the control valve, and that it is properly aligned and supported.

A system for the complete by-passing and isolation of the softener should be installed (see Section 7.1.6).

6.1.5 Water Supply Company Requirements

It is essential that if the equipment is to be connected directly to a mains water supply, the local bylaws must be adhered to. These cover both plumbing and the prevention of backflow into the mains. If there is any doubt, the local water inspector should be consulted, but in general, the installation of a 'Double check valve assembly' conforming to BS6282 part 2 will be required in the feed pipework to the softener.

If the pressure available from the mains is not adequate it will be necessary to install a booster pump arrangement. Such a system would be covered by additional bylaws, and the water storage tank needed must comply with these.

6.2 ELECTRICAL

A continuous supply of 24v, 5 VA is required by the softener. A 240v transformer with an output of 9.6 VA is provided, which should be connected to an uninterrupted mains supply, which is separately 1 Amp fused, and does not have any additional switch.

It is recommended that the transformer be attached to a nearby wall, within 500 mm of the softener in an area free from water spray or excessive heat or condensation.

A plug is not provided with this softener since the cable should be connected to fused spur outlet. However if that is not possible then a plug should be fitted to the cable with a 1 amp fuse. The socket used should be un-switched to prevent the softener from being inadvertently turned off.

5600SE Simplex Series Watersoftener

Installation Operation Maintenance Manual

7.0 ASSEMBLY/INSTALLATION

7.1 MECHANICAL

Check all the items against the parts list and shipping documents, and ensure you have them all before starting work. In addition to the softener you will require installation materials and basic tools, (i.e., spanners, screwdrivers etc., and PTFE tape)

7.1.1 Simplex Models

Assembling Vessel, Riser Tube and Internals

Simplex units are shipped as pre-assembled components to reduce the risk of transit damage. These need to be assembled on site. Open the carton containing the pressure vessel and remove it. Check that the vessel has not been damaged in transit. Pay particular attention to the vessel top hole threads, as this is where the valve will seal. Check that there is no dirt or swarf inside.

Riser Tube/Bottom Filter

This comprises a length of pipe (the 'riser tube') to one end of which is glued a moulded screen. The other end is fitted into the bottom of the control valve. To make sure the riser fits properly, and there is no leakage, it will be supplied to the correct length prior to despatch.

7.1.2 Charging the Resin

The ion exchange resin is supplied in 25 litre bags plus a part bag if applicable. All models will be supplied with exactly the right quantity of resin. It is important that only the correct volume of resin is put into the vessel or the system will not function properly. (See **Section 12.1.2** for data)

Place the vessel in its final location - once filled with resin and water they should not be moved. Fill the vessel about 1/5 full with clean water. The riser is 45 mm shorter than the internal height of the vessel so in order to keep it centrally located and prevent resin falling inside the riser, and 'extender/cover' is provided to be slipped over the end of the riser when filling with resin. This must be carefully removed without disturbing the riser prior to fitting the control valve. Carefully open the resin bags and pour the resin into the vessel, using the funnel provided, keeping the riser tube central and upright. Take great care not to spill resin on the floor. If any is spilt, make sure it is swept up immediately, as it is very easy to slip on it. Wash away any loose resin

5600SE Simplex Series Watersoftener

Installation Operation Maintenance Manual

from the threads of the vessel or adapter collar. Remove the riser extender cover and check that the top of the riser is still correctly located

7.1.4 Assembling the Control Valve

Carefully remove the control valve from its packing, and check that all parts are present. Fit the top filter/distributor to the valve. This is a 'snap' bayonet fit.

7.1.5 Attaching the Control Valve

Carefully fit the control valve on to the vessel, taking care to ensure that the riser tube locates correctly into the valve base through the top distributor, and that the threads are not crossed. Also take care to make sure that the 'O'rings are properly seated and not pinched.

7.1.6. Brine System

Move brine tank into position and connect the outer port of the bulk head union to the brine draw connection on the valve using the 3/8" tubing. Make sure that this connection is also tight to stop air leaking in.

If brine draw tubing is adjusted for length during installation, ensure that brass tubing inserts are refitted into tubing end prior to connecting into brine tank and control valve.

7.1.7 Pipework

Pipework should be assembled incorporating the features shown in the Installation Diagram, Section 14.1. It is essential that inlet and outlet isolating valves and a by-pass valve are provided, and that the water main is protected by a double check valve where appropriate (see Local Water Bye-laws).

In domestic premises it is recommended that a hard water supply is still used for drinking water (see General Notes Section 1.0).

Pipework can be constructed from any normally acceptable material (Copper, Galvanised, Plastic), provided it is properly supported and aligned. Ensure that the pipe is sufficiently large to accommodate the flow of water required, making due allowance for the pressure drop between the softener and the point of discharge of soft water.

NOTE: IF BRAZED OR SOLDERED FITTINGS ARE TO BE USED, THE PIPEWORK MUST BE DISCONNECTED FROM THE VALVE

5600SE Simplex Series Watersoftener

Installation Operation Maintenance Manual

DURING HEATING AND COOLING. EXCESS HEAT CAN CAUSE PERMANENT DAMAGE TO SOME OF THE VALVE COMPONENTS.

The inlet and outlet pipework should be connected to the horizontal, rear facing connections on the rear of the valve manifold (1" BSP Female) (see Fig 1 in Section 14.1).

7.1.8 Storage tank ball valve

Conventional ball float valves pass water at a slow trickle into storage tanks and cisterns when they are shutting off. Trickle flow is not recommended for satisfactory functioning of a water softener since channelling can occur through the resin bed and the meter may not accurately monitor very low flows. It is therefore recommended that main storage tanks for softened water should have the ball valve replaced with a servo type valve such as a Torbeck or Fluidmaster which permit full flow until they close off. These are inexpensive and are a direct replacement for the more common brass ball float valves.

7.1.9 Drains and overflow connections

Connect the overflow fitting on the brine tank to a suitable drain, using flexible or rigid tubing. Make sure that there is a clear gap of approximately 50 mm between the end of the tube and the top of the drain tundish or gully edge.

The drain connection from the valve is a 1/2" hose spigot. Flexible tube should be run from this spigot to a drain capable of taking the maximum flow in regeneration (see Section 12.1), and leaving a similar gap above the drain edge. The drain must not be higher level than the 500mm above the control valve and preferably should have an air break at the same height as the control valve. A standard washing machine upstand is quite suitable for this.

7.1.10 Blending System

For those applications where it is advantageous to retain some hardness in the treated water, a blending system has been fitted. This is controlled by a rotating knob on the left side of the control valve.

5600SE Simplex Series Watersoftener

Installation Operation Maintenance Manual

7.2 ELECTRICAL

Electrical installation is very straightforward, but should still be carried out by a competent electrician, and must conform to the appropriate standards of safety.

7.2.1 Mains Supply

The mains supply should be through a separate, switched supply, fused and earthed in accordance with Institute of Electrical Engineers Regulations. Current rating should be 1 Amp.

7.2.2 Transformer

A safety transformer is provided to reduce the voltage to 24 Volts to operate the controls.

This should be attached to a convenient wall, within 500mm of the softener. **DO NOT SWITCH ON THE ELECTRICAL SUPPLY AT THIS STAGE** See Fig 3 in Section 14.2

5600SE Simplex Series Watersoftener

Installation Operation Maintenance Manual

8.0 COMMISSIONING

8.1 INTRODUCTION

It is recommended that the commissioning of the plant is undertaken by a trained service engineer, who will be able to put the plant into service quickly, and most efficiently. However, if the services of an experienced engineer are not available, following the steps outlined below will result in the system being properly commissioned.

8.2 CONTROLLER SETTING - Site programming mode

All controller settings will require the valve to have a mains supply switched on. The valve must not be regenerating when controller settings are adjusted.

8.2.1 Setting the Time of Day

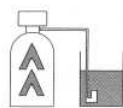
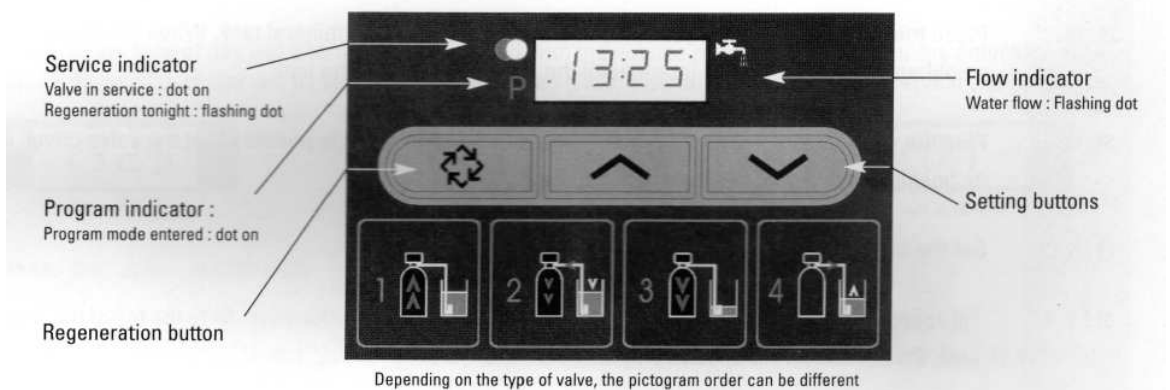

Backwash

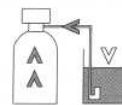

Brine draw & slow rinse
Up flow



Brine draw & slow rinse
Down flow



Rapid rinse



Brine refill





Symbol means cycle not used on
Filter valve



Note: depending on the type of valve, some of these symbols will be used.

Meter controlled valves: The display alternates between the time of day on the left and the remaining calculated capacity in litres on the

5600SE Simplex Series Watersoftener

Installation Operation Maintenance Manual

right. Wait until the time of day is displayed and then press the up  and down  arrow keys until the correct time of day is displayed.



Time clock only valve: The time of day is permanently displayed. Press the up  and down  arrow keys until the correct time of day is displayed.

8.2.2 Site programming - Setting the capacity, time of day of regeneration and regeneration override.

The softener regeneration cycles have been factory programmed. On metered softeners the volume capacity of the resin in litres has also been entered based on a default hardness of 20 Degrees Clark and a reserve capacity of 33%. This may need to be altered based on local water hardness and reserve required for the occupants of the property (see section 13.1).

The time of day set for regeneration to take place has been entered as 2:00 AM and this may need to be altered depending on site requirements.

On metered softeners, the regeneration override is used to freshen the resin if a regeneration has not taken place for a number of days. On time clock softeners the override is used to set the frequency of regeneration.

Press and hold the press the up  and down  arrow keys together for 5 seconds. On metered softeners only the volume capacity of the resin in litres will be displayed. This can be adjusted to suit site conditions by pressing the up and down arrows.

Press the extra cycle button to set the time of day of regeneration. The default is set to 2:00 am. This may be changed to any other convenient time by pressing the up and down arrows.

Press the extra cycle button to set the regeneration override. The default is 7 days for metered softeners and every 3 days for time clock softeners. This may be changed to a different interval by pressing the up and down arrows.

Press the extra cycle button to exit the Site Programming mode.

5600SE Simplex Series Watersoftener

Installation Operation Maintenance Manual

8.3 BRINE SYSTEM

8.3.1 Salt Tank Filling

Place approximately 100 mm depth of water in the bottom of the cabinet. Fill with pellet salt (recommended) until the cabinet is full or with granular salt until it is 3/4 full.

Overfilling the cabinet with granular salt can result in an overflow of brine. This cannot happen with pellet salt which is why it is recommended.

Under no circumstances use cooking salt or Pure Vacuum Dried (PVD) salt to fill the cabinet as either of these will damage the resin and the internal components of the regeneration valve and brine draw system.

5600SE Simplex Series Watersoftener

Installation Operation Maintenance Manual

8.4 PRE-SERVICE FLUSH AND REGENERATION

Set the manual isolating valves so that water will by-pass the softener. Turn on the main water supply. Open a soft water tap close by and let the water run for a few minutes to flush out any debris or foreign matter from the pipework system.

Turn on the power supply to the valve.

Press the extra cycle button for five seconds. The display will then indicate 1-----. Wait for the controller to advance the valve until a time in minutes appears on the right of the display.

Slowly open the mains inlet isolating valve until water starts to flow slowly from the drain line. Air will escape initially through the drain line. When water begins to flow steadily, open the valve fully.

Press the 'Extra Cycle' button four times more to return the valve to service. After each press, wait for a time to appear on the right of the display. There will be loud 'click' as the brine valve closes while the valve advances from position 2 to position 3, and from position 4 to the home position.

Finally press the 'Extra Cycle' button to initiate a complete regeneration and refill the brine tank to the correct level. Do not advance any of the cycles.

During regeneration the softener will pass hard water to service. The bypass can therefore be closed and the outlet valve opened. When the softener returns to service then soft water will be available.

8.5 Blending System

The valve has a built in blending adjustment on the left of the valve body behind and below the control valve powerhead. The blender is factory set to **fully closed**.

Blending is not normally required for domestic applications but is occasionally used for industrial processes where a small amount of hardness is used in conjunction with special chemicals.

The blender is not calibrated. The blend flow must also be set with the water flowing through the softener at its normal working flow rate.

This is done by trial and error. When the unit is in service, open the blend controller, by turning the knob **clockwise** half a turn. Check the

5600SE Simplex Series Watersoftener

Installation Operation Maintenance Manual

downstream water hardness with a test kit and then turn the knob open or closed to adjust the harness to the required level.

A change will then need to be made to the valve programming on metered softeners. See section 13.4 'Custom settings' for information on adjusting the valve program to work correctly with the blender.

5600SE Simplex Series Watersoftener

Installation Operation Maintenance Manual

9.0 OPERATION

9.1 NORMAL OPERATION

Operation is completely automatic, with regeneration being initiated whenever required by the meter controller.

9.2 REFILLING WITH SALT

Since salt is used in the regeneration process, the level of salt in the brine tank will fall after each regeneration. It should not be allowed to fall below 75 mm above the bottom of the cabinet. When the low level is approached (or more often, as a routine) the cabinet should be refilled to the top with pellet salt or 3/4 filled with granular salt.

The approximate capacity of the cabinet for salt is shown in Section 12.1.

9.3 MANUAL REGENERATION

There can be occasions during the life of equipment such as softeners when the original design basis is not applicable. For example, after a shutdown period, the demand for soft water may far exceed the design flow rate for a short period. Another possibility is that the Water Service Plc finds it necessary to change to a supply which is much harder than that normally received. It will then be necessary to give the unit an additional regeneration to ensure that soft water continues to be available to service.

This additional regeneration is initiated manually.

Press and hold in the 'Extra Cycle' button for five seconds until the number 1----- appears in the display. Regeneration will proceed automatically immediately.

If the 'Extra Cycle' button is only pressed briefly, the 'Service' indicator will begin to flash immediately and a regeneration will occur at the normal regeneration time (2:00 am set as default).

9.4 BY-PASSING THE SOFTENER

There may be occasions when it is desirable to by-pass the softener, to allow hard water to go to service, or if the softener is for some reason not performing properly.

To do this, open the by-pass isolating valve and close the softener outlet isolating valve (see Installation Diagram, Fig 3 in Section 14.2).

5600SE Simplex Series Watersoftener

Installation Operation Maintenance Manual

The softener can still be safely regenerated with the valves in this position. If for any reason, it is desired to completely isolate the softener, it will be necessary to close the inlet isolating valve as well.

9.5 TEMPORARY SHUT-DOWN

The softener can be left indefinitely without use. During periods of low or minimal water use, for example during vacation absences, the valve controller will automatically regenerate the resin at the frequency set in the regeneration override.

If the softener needs to be taken out of service for some time for any other reason, it is recommended that one or two simple procedures be undertaken to ensure the return to operation is as smooth as possible.

1. The unit should be left regenerated.
2. The electrical supply should be turned off
3. The inlet and outlet manual isolating valves should be closed.
4. The valve should be drained of water if there is the possibility of the system freezing.

On restart, it will be necessary to reset the 'time of day. It is also recommended that the unit be regenerated again before being put into service.

9.6 CHANGES IN INCOMING WATER

There is a much greater tendency these days for the Water supply Plc to use water from more than one source. It is unlikely that two sources will have similar chemical composition, and so when this happens the raw water being fed to the unit may also change. It is suggested that routine monitoring be undertaken to check whether this is the case (see 9.9). If variation greater than 5% is found, it will be necessary to check whether the settings for regeneration need changing. Resetting is the same as setting.

5600SE Simplex Series Watersoftener

Installation Operation Maintenance Manual

9.7 ROUTINE MONITORING

The following recommendations are made to help the user of the softener confirm that it is performing as required, and to give early warning of possible problems. The operation of the softener is completely automatic, and should not require adjustment (except as above).

Weekly

Check the treated water hardness with a hardness test kit.
Inspect the level of salt in the salt tank and refill if necessary.

Monthly

Check raw water hardness, and record. Compare with original hardness and adjust volume capacity setting if required (see Section 13.1).

Annually

Inspect and clean/replace as necessary the brine injector, piston and the internal seals. This should be performed by a competent engineer familiar with Fleck valves.

5600SE Simplex Series Watersoftener

Installation Operation Maintenance Manual

10.0 FAULT FINDING AND RECTIFICATION

Modern water softeners are extremely reliable and unlikely to give any problems if they are installed and operated correctly.

10.1 NO FLOW TO SERVICE

Check mains pressure is above 1.7 bar.

Check inlet and outlet isolating valves are open.

Check service outlet valve is open.

Check pressure drop across resin. If excessive, resin may be fouled, or internals blocked. Initiate a regeneration. If this does not free up the resin the softener will need to be inspected and serviced by a competent engineer.

10.2 POOR TREATED WATER QUALITY

Check manual by-pass closed.

Check blending valve has not been opened or adjusted.

Check salt level in salt tank. Refill if necessary.

Trickle flow through conventional ball valve in storage tank. Replace with Torbeck or Fluidmaster servo valve.

Check raw water pressure above minimum. If flow is less than minimum, channelling of water can occur in resin. which results in inadequate treatment.

Check injector strainer and injector not blocked (see Appendix for drawings). Clean if necessary.

Check brine pick-up screen not blocked. Clean if necessary.

Check brine line not split. Replace if necessary.

Check raw water hardness, and then check if controller setting is correct for this hardness (see Section 8)

5600SE Simplex Series Watersoftener

Installation Operation Maintenance Manual

10.3 NO REGENERATION

Check electrical supply, fuses etc. satisfactory.

Check control head motor runs, by initiating a manual regeneration, and listening for drive motor gently 'ticking' as it advances between cycles. Replace if necessary.

Check meter running freely (if fitted) indicated by running a treated water outlet and watching the flow indicator and 'volume remaining' reading on the display count down at the same rate as the water flow.

10.4 UNSATISFACTORY CAPACITY BETWEEN REGENERATIONS

See Section 10.2.

Check condition of resin. It may have become fouled, inhibiting the regeneration process. If fouled, it should be cleaned or replaced.

Check incoming water for presence of Chlorine. If high, the resin may have been degraded.

Check raw water pressure. Too high pressure may mean the brine draw stage of regeneration is not effective

5600SE Simplex Series Watersoftener

Installation Operation Maintenance Manual

11.0 WARRANTY AND SERVICE

11.1 AFTER SALE WARRANTY

Your softener is covered by a parts warranty for a period of one year from installation.

Should you have any problems with your softener or require routine service, please contact your supplier.

5600SE Simplex Series Watersoftener

Installation Operation Maintenance Manual

12.1 PROCESS AND OPERATING DATA

12.1.1 5600SE Series Water Softeners 10-30 litre

MODEL		10 L	14 L	20 L	25 L	30 L
PARAMETER	UNITS					
Max. Service Flow	M3/hr	0.50	0.70	1.00	1.25	1.50
Min Service Flow	M3/hr	0.05	0.07	0.10	0.13	0.15
Capacity	m3ppm	500	700	1000	1250	1500
Volume treated between regens (300 ppm CaCO ₃ , 21° Clarke)	M3	1.67	2.33	3.33	4.17	5.00
Salt used per regeneration	kg	1.4	1.96	2.8	3.5	4.2
Regeneration Time	mins	37	48	60	66	71
Resin Volume	litres	10	14	20	25	30
Salt Storage Capacity	kg	80	80	80	80	80
No of Regens Salt stored	-	57	40	28	22	18
Maximum Flow to drain	Lit/min	4.6	4.6	4.6	5.7	7.6

IMPORTANT NOTES

Much of the data quoted in the above table is affected by the inlet pressure, and so should be regarded as nominal only.

Total flow to drain will be similarly affected and is therefore not quoted, but will be about 6 times the resin volume.

5600SE Simplex Series Watersoftener

Installation Operation Maintenance Manual

12.1.2 5600SE/5700 Series Water Softeners 40-75 litre

MODEL		40 L	50 L	60 L	75 L
PARAMETER	UNITS				
Max. Service Flow	M3/hr	1.20	2.00	2.40	3.00
Min Service Flow	M3/hr	0.12	0.20	0.24	0.30
Capacity	m3ppm	2000	2500	3000	3750
Volume treated between regens (300 ppm CaCO ₃ , 21° Clarke)	M3	6.67	8.33	10.00	12.50
Salt used per regeneration	kg	5.6	7.0	8.4	10.6
Regeneration Time	mins	78	83	73	83
Resin Volume	litres	40	50	60	75
Salt Storage Capacity	kg	120	120	200	200
No of Regens Salt stored	-	21	17	23	18
Maximum Flow to drain	Lit/min	7.6	7.6	9.1	13.3

IMPORTANT NOTES

Much of the data quoted in the above table is affected by the inlet pressure, and so should be regarded as nominal only.

Total flow to drain will be similarly affected and is therefore not quoted, but will be about 6 times the resin volume.

5600SE Simplex Series Watersoftener

Installation Operation Maintenance Manual

12.2 ENGINEERING DATA

12.2.1 10-30 lit 5600SE/5700 Series Water Softeners

MODEL		10 L	14 L	20 L	25 L	30 L
PARAMETER	UNITS					
Diameter of vessel/valve	mm	220	220	220	250	270
Height to top of valve	mm	640	800	1105	1105	1105
Diameter of brine tank	mm	460	460	460	460	460
Height of brine tank	mm	630	630	630	630	630
Inlet Conn.	ins BSPF	1.0	1.0	1.0	1.0	1.0
Outlet Conn.	ins BSPF	1.0	1.0	1.0	1.0	1.0
Drain Conn.	ins	1/2	1/2	1/2	1/2	1/2
Brine Tank Overflow Conn.	ins	3/4	3/4	3/4	3/4	3/4
Delivered Wt.	Kg.	16	22	34	39	44
Working Wt. (approx)	Kg	46	57	94	99	104
Maximum Flow to drain	Lit/min	4.6	4.6	4.6	5.7	7.6
Electrical Power	v	240	240	240	240	240
	Hz	50	50	50	50	50
	V/A	1.2	1.2	1.2	1.2	1.2

MAXIMUM OPERATING PRESSURE 5.5 Bar MINIMUM OPERATING
 PRESSURE 1.7 Bar MAXIMUM OPERATING TEMPERATURE 50.0C
 HEADROOM - Allow 100 mm greater than overall height.

5600SE Simplex Series Watersoftener

Installation Operation Maintenance Manual

12.2.2 40-75 lit 5600SE/5700 Series Water Softeners

MODEL		40 L	50 L	60 L	75 L
PARAMETER	UNITS				
Width of vessel/valve	mm	270	270	315	330
Height to top of valve	mm	1320	1580	1420	1570
Diameter of brine tank	mm	465	465	555	555
Height of brine tank	mm	800	800	980	980
Inlet Conn.	ins BSPF	1.0	1.0	1.0	1.0
Outlet Conn.	ins BSPF	1.0	1.0	1.0	1.0
Drain Conn.	ins	1/2	1/2	1/2	1/2
Brine Tank Overflow Conn.	ins	1/2	1/2	1/2	1/2
Delivered Wt.	Kg.	55	65	75	90
Working Wt. (approx)	Kg.	170	180	300	320
Maximum Flow to drain	Lit/min	7.6	7.6	9.1	13.3
Electrical Power	v	240	240	240	240
	Hz	50	50	50	50
	V/A	1.2	1.2	1.2	1.2

MAXIMUM OPERATING PRESSURE 5.5 Bar MINIMUM OPERATING
 PRESSURE 1.7 Bar MAXIMUM OPERATING TEMPERATURE 50.0C
 HEADROOM - Allow 100 mm greater than overall height.

5600SE Simplex Series Watersoftener

Installation Operation Maintenance Manual

13.0 Factory Programming

13.1 Master Program Settings

Master Program set up summary

Details applicable to each valve or programming type are in the columns 'T/C' (Timeclock) and 'DEL' (Delayed regeneration). Regeneration cycle data applicable to each resin volume is shown in the resin volume columns. The treated water capacity is entered as 66% of the resin capacity at 300 ppm giving a 33% reserve.

To adjust any of these settings see the following section, 13.2

Parameter description	T/C	DEL	Res Vol	10	14	20	25	30
Metric format with 24 hr clock	U--2	U--2						
Regeneration type	7--1	7--3						
Capacity (lit)		see across	⇒	1100	1530	2660	2750	3300
Regen time	2:00	2:00						
Regen day override	A--3	A--7						
Reg step 1	see across	see across	⇒	4	4	4	4	4
Reg step 2	see across	see across	⇒	30	30	40	40	40
Reg step 3	see across	see across	⇒	4	4	4	4	4
Reg step 4	see across	see across	⇒	4.2	5.9	8.2	10.5	12.6
Reg step 5	OFF	OFF						
Flow meter size		35.1						
Valve type	o--1	o--1						
Line frequency	LF50	LF50						
Exit to time of day								

5600SE Simplex Series Watersoftener

Installation Operation Maintenance Manual

Parameter description	T/C	DEL	Res Vol	40	50	60	75
Metric format with 24 hr clock	U--2	U--2					
Regeneration type	7--1	7--3					
Capacity (lit)		see across	⇒	4400	5500	6600	8250
Regen time	2:00	2:00					
Regen day override	A--3	A--7					
Reg step 1	see across	see across	⇒	5	5	5	5
Reg step 2	see across	see across	⇒	50	50	60	60
Reg step 3	see across	see across	⇒	6	6	6	6
Reg step 4	see across	see across	⇒	17.6	20.1	12.6*	15.7*
Reg step 5	OFF	OFF					
Flow meter size		35.1					
Valve type	o--1	o--1					
Line frequency	LF50	LF50					
<i>Exit to time of day</i>							

***0.50 gpm BLFC**



5600SE Simplex Series Watersoftener

Installation Operation Maintenance Manual

13.2 Master Programming

This section is for information only. The valve is pre-programmed and will not need adjustments made to the Master Level Program unless custom settings are required.

Set the time of day display to 12:01

Press and hold the press the up  and down  arrow keys together for 5 seconds.

A 'U' will appear in the left of the display. The number on the right sets the controller for the 'metric' countercurrent regeneration program and the display on the metered softener to read in litres. This should be set to 'U--2

Press Extra Cycle button again to set regeneration type which is prefixed '7'

7--1 = Timeclock delayed (used for timeclock only softeners)

7--2 = Metered immediate regeneration

7--3 = Metered delayed regeneration. This is the factory setting for metered softeners.

Press Extra Cycle button again to set system capacity. This has the same function as the capacity setting in the Site Setting program - see section 8.2.2. Factory set to system volume capacity at 300 ppm with 33% reserve. Section 13.3 details the softener outputs at differing hardness levels.

Press Extra Cycle button again to set the time of day of regeneration. This has the same function as the regeneration time setting in the Site Setting program - see section 8.2.2. The default is set to 2:00 am.

Press Extra Cycle button again to set the regeneration day override. This has the same function as the regeneration day override setting in the Site Setting program - see section 8.2.2. The default is set to 'A--7' days for metered softeners and 'A--3' days for time clock softeners. To cancel the setting on metered softeners set the display to 'AOFF'. A 'day' setting **must** be displayed for time clock softeners to work.

Press the Extra Cycle button again to set regeneration cycle 1 - backwash. Set this as shown in the table above.

Press the Extra Cycle button again to set regeneration cycle 2 - brine draw and slow rinse. Set this as shown in the table above.

Press the Extra Cycle button again to set regeneration cycle 3 - fast rinse. Set this as shown in the table above.

5600SE Simplex Series Watersoftener

Installation Operation Maintenance Manual

Press the Extra Cycle button again to set regeneration cycle 4 - brine refill. Set this as shown in the table above.

Press the Extra Cycle button again to set regeneration cycle 5 - RESERVED SETTING. **MUST BE SET TO 'OFF'**.

Press the Extra Cycle button again to set the flow meter size on metered softeners. With metric settings the display should read 35.1

Press the Extra Cycle button again to set the valve type. This **must** be set to 'o--1' for the 5600SE valve.

Press the Extra Cycle button again to set the line frequency. For European 50 Hz supplies this **must** be set to 'LF50'

Press the Extra Cycle button again to exit the Master Programming mode

5600SE Simplex Series Watersoftener

Installation Operation Maintenance Manual

13.3 Softener output (capacity) at differing hardness levels

Outputs detailed in litres

Lit resin	10	14	20	25	30	40	50	60	75
Hardness (ppm)									
100	5000	7000	10000	12500	15000	20000	25000	30000	37500
125	4000	5600	8000	10000	12000	16000	20000	24000	30000
150	3333	4667	6667	8333	10000	13333	16667	20000	25000
200	2500	3500	5000	6250	7500	10000	12500	15000	18750
225	2222	3111	4444	5556	6667	8889	11111	13333	16667
250	2000	2800	4000	5000	6000	8000	10000	12000	15000
300	1667	2333	3333	4167	5000	6667	8333	10000	12500
325	1538	2154	3077	3846	4615	6154	7692	9231	11538
350	1429	2000	2857	3571	4286	5714	7143	8571	10714
375	1333	1867	2667	3333	4000	5333	6667	8000	10000
400	1250	1750	2500	3125	3750	5000	6250	7500	9375
425	1176	1647	2353	2941	3529	4706	5882	7059	8824
450	1111	1556	2222	2778	3333	4444	5556	6667	8333
475	1053	1474	2105	2632	3158	4211	5263	6316	7895
500	1000	1400	2000	2500	3000	4000	5000	6000	7500

When setting the capacity of the softener, allowance must be made for a 24 hour reserve on metered units. On domestic supplies this should be calculated at 150 litres per person per day unless meter reading data is available that is substantially different.

eg 1: A 30 litre softener at 400 ppm supplying a four person household should be set to a capacity of:

$$3750 - (4 \times 150) = 3150 \text{ litres}$$

eg 1: A 10 litre softener at 225 ppm supplying a two person household should be set to a capacity of:

$$2222 - (2 \times 150) = 1622 \text{ litres}$$

The factory default setting is 66% of the capacity at 300 ppm.

5600SE Simplex Series Watersoftener

Installation Operation Maintenance Manual

13.4 Custom Programming

There are two variations on the settings that may be required. Both need adjustments to be made through the Master Programming Mode.

13.4.1 Using blender. If the blender fitted to the valve is to be used, the valve capacity needs to be adjusted. This means that the valve will still be able to calculate when the resin should be regenerated without wasting salt.

You will first need to adjust the blender and check the hardness of the blended water on site during normal service flow.

Next, calculate the percentage or proportion of the blended water when compared with the raw water. If, for example, the hardness of the blended water is 60 ppm, and the raw water is 300 ppm, the proportion of blended water is $60/300 = 1/5$, or 20%. The 'capacity' of the softener can then be increased by 20%, saving salt.

13.4.2 Immediate regeneration. The valve is factory programmed for delayed regeneration which means that it will check whether it has zeroed out at the pre-programmed regeneration time (factory set to 2:00 AM).

However the valve can also be set for 'immediate' regeneration when it will regenerate as soon as the water meter zeroes out at any time of the day. The setting is made in step 2 of the Master Programming mode when the setting should be changed to 7--2. (see section 13.2)

No reserve needs to be allows for the system capacity when the softener is programmed for immediate regeneration.

Please note, that there will then be no 'regeneration time of day' option presented during the Master or Site Programming modes when immediate regeneration is selected.

5600SE Simplex Series Watersoftener

Installation Operation Maintenance Manual

14.0 Drawings

14.1 Installation Layout

Fig 1 General Installation Layout 5600SE Simplex Softeners

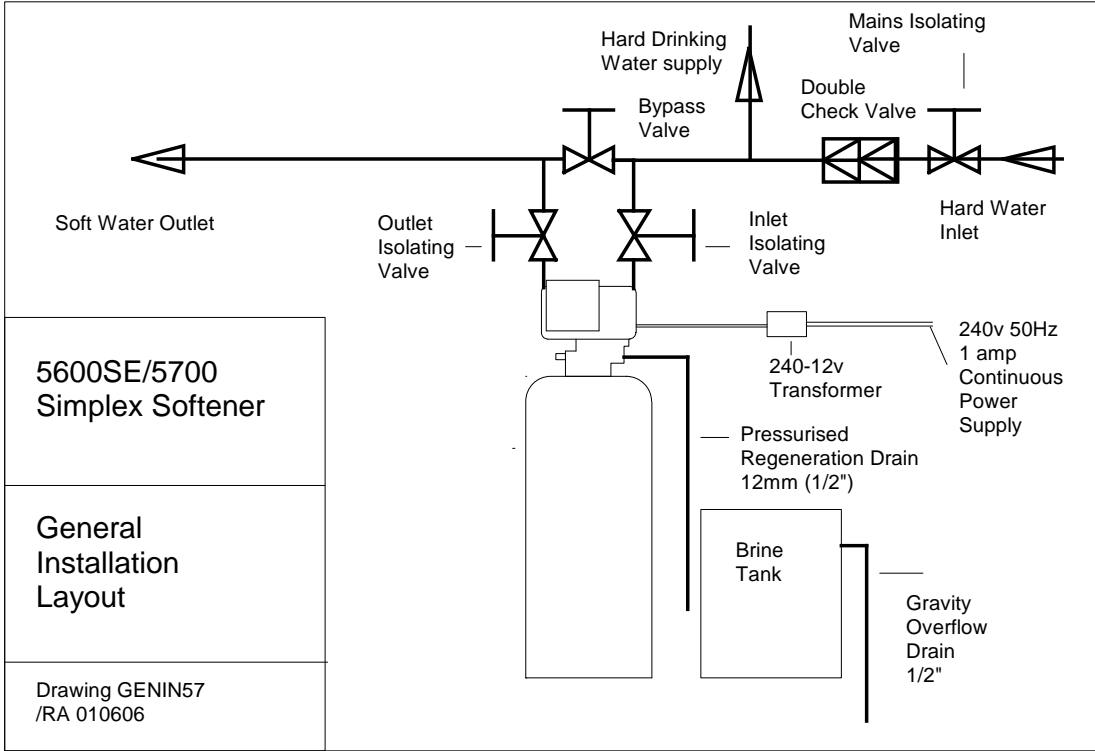

5600SE Simplex Series Watersoftener

Installation Operation Maintenance Manual

Manufacturer's Declaration of Conformity

We the undersigned

EURAQUA UK, HITCHIN, ENGLAND

Certify that the product

*type: SIMPLEX WATER SOFTENER WITH FLECK 5600SE/5700
24 VOLT AC VALVE*

*has been designed and manufactured in accordance with the
specifications of the following:*

Directive

Machinery Directive 89/392/EEC
Low Voltage Directive 73/23/EEC
EMC-Directive 89/336/EEC

Standard

EN 292-1, EN 292-2
EN 60 335-1
EN 55 014

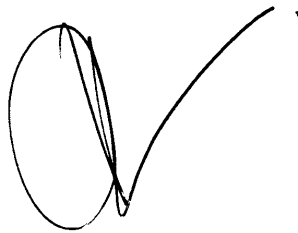

RT Adam
Director

Hitchin, England 01/01/01
Issue place & date